



SERIES 150 Vinyl

Low Fixed Picture

Technical Specifications
and Cross-Sectional
Details

Table of Contents

- CONSTRUCTIONS SPECIFICATIONS - SECTION 08 54 00 2
- PART 1 GENERAL 2
 - 1.1. SECTION INCLUDES 2
 - 1.2. REFERENCES 2
 - 1.3. SUBMITTALS 2
 - 1.4. QUALITY ASSURANCE 3
 - 1.5. STORAGE AND HANDLING 3
 - 1.6. WARRANTY 3
- PART 2 PRODUCTS 3
 - 2.1. MANUFACTURED UNITS 3
 - 2.2. FABRICATION 3
- PART 3 EXECUTION 5
 - 3.1. EXAMINATION 5
 - 3.2. INSTALLATION 5
 - 3.3. FIELD QUALITY CONTROL 5
 - 3.4. CLEANING 5
 - 3.5. PROTECTING INSTALLED CONSTRUCTION 5
- WINDOW TYPE AND CLASSIFICATIONS 7
- ENERGY STAR 8
- THERMAL RESULTS 10
 - LOW FIXED PICTURE WINDOW 10
- CROSS SECTIONS 11
 - LOW FIXED PICTURE WINDOW 11
 - MULLING ASSEMBLY 12
 - GRILL + SDL OPTIONS 13
- TEST REPORTS 14

CONSTRUCTIONS SPECIFICATIONS - SECTION 08 54 00

PART 1 GENERAL

1.1. SECTION INCLUDES

- A. Series 150 Vinyl Picture Low Fixed Window complete with glazing, mulling options, weather strip, grilles-between-the-glass, jamb extension, exterior brickmould trims, exterior sill extension and standard or specified anchors, trim and attachments

1.2. REFERENCES

- A. ASTM International (ASTM)
 - 1. American Society for Testing and Materials (ASTM):
 - 2. C1036: Standard Specification for Flat Glass.
 - 3. E 283: Standard Test Method for Rate of Air Leakage through Exterior Windows, Curtain Walls and Doors.
 - 4. E 330: Standard Test Method for Structural Performance of Exterior Windows, Curtain Walls, and Door by Uniform Static Air Pressure Difference.
 - 5. E 547: Standard Test Method for Water Penetration of Exterior Windows, Curtain Walls, and Doors by Cyclic Static Air Pressure Differential.
 - 6. E 2190: Standard Specification for Insulating Glass Unit Performance Evaluation.
 - 7. F 2090-10: Standard Specification for Window Fall Prevention Devices with Emergency Escape (Egress) Release Mechanisms.
- B. American Architectural Manufacturer's Association/Window and Door Manufacturer's Association/Canadian Standards Association (AAMA/WDMA/CSA): (use appropriate specifications depending on certification for each product type).
- C. AAMA/WDMA/CSA 101/I.S.2/A440-08/11,S11-09: North American Fenestration Standard/Specification for windows, doors, and skylights.
- D. AAMA 450-10: Voluntary Performance Rating Method for Muller Fenestration Assemblies
- E. Window and Door Manufacturer's Association (WDMA): Keystone Certification Program
- F. Insulating Glass Manufacturer's Alliance/Insulating Glass Certification Council (IGMA/IGCC).
- G. National Fenestration Rating Council (NFRC):
 - 1. 101: Procedures for Determining Fenestration Product Thermal Properties.
 - 2. 200: Procedure for Determining Solar Heat Gain Coefficients at Normal Incidence

1.3. SUBMITTALS

- A. Shop Drawings: Submit shop drawings.
- B. Samples: Specified performance and design requirements.
- C. Quality Control Submittals: Certificates: Submit manufacturer's certification indicating compliance with specified performance and design requirement

1.4. QUALITY ASSURANCE

- A. Requirements: consult local code for NBC [National Building Code] adoption year and pertinent revisions for information on:
- B. Egress, emergency escape and rescue requirements.
- C. Basement window requirements.
- D. Windows fall prevention and/or window opening control device requirements.

1.5. STORAGE AND HANDLING

- A. Applicable frames and mulled units will include additional bracing to maintain squareness and rigidity during shipment.
- B. Store window units in an upright position in a clean and dry storage area above ground to protect from weather.

1.6. WARRANTY

The following limited warranty is subject to conditions and exclusions. There are certain conditions or applications over which EVERLAST Group of Companies has no control. Defect or problems as a result of such conditions or applications are not the responsibility of EVERLAST Groups of Companies. For a more complete description of the EVERLAST limited warranty, refer to the complete and current warranty information available by request.

Clear insulating glass with stainless steel spacers is warranted against seal failure caused by manufacturing defects and resulting in visible obstruction through the glass for twenty (20) years from the original date of purchase. Glass is warranted against stress cracks caused by manufacturing defects for ten (10) years from the original date of purchase.

Hardware and other non-glass components are warranted to be free from manufacturing defects for two (2) years from the original date of purchase.

PART 2 PRODUCTS

2.1. MANUFACTURED UNITS

- A. Description: Altitude Picture Fixed units as manufactured by EVERLAST Group of Companies
 - Calgary, Alberta, Canada

2.2. FABRICATION

- A. Frame:
 - 1. Frame – Vinyl: members shall be manufactured from .079" [2mm] extruded unplasticized polyvinylchloride (uPVC). Frame corners shall be fusion welded and cleaned.
 - 2. Frame Depth – Vinyl: Frame shall have standard jamb depth of 3-1/4" [57.15mm] with integral nailing fin and an overall profile thickness of 4-1/4" [108mm].
 - 3. Interior and exterior frame expander accessory is factory installed.

4. Interior and exterior fabricated frame expander components, including head-jamb, sill and both jamb components.

B. GLAZING

1. Select quality complying with ASTM C 1036. Insulating glass SIGMA/IGCC when tested in accordance with ASTM E 2190. STC/OITC ratings are tested to the stated performance level in accordance with ASTM E 90-09.
2. Glazing Method: 7/8" (22mm), 1" (25.4mm) and 1 1/4" (31.75mm) insulating glass. Dual and Triple glazing.
3. Glass Type: LoE Cardinal IG® i89, 180, 270, 272 and 366 with Air or Argon Gas.
4. Glass Type Options: Obscure Glass, Sand Blasted, Rain Glass, Glue Chip, Narrow Reed, Reed, Bronze Tint, Gray Tint, Green Tint.
5. Glazing Seal: Silicone bead at exterior; interior has glazing boot inserted.
6. Perimeter Spacer: Default color is mill finish (stainless).
7. Glazing Option: STC/OITC upgrade.

C. MULLING

1. Directional mull limits: 6 wide by 1 unit high; Rough Opening not to exceed 114" x 84" (2896mm x 2134mm).
2. Directional mull limits: 5 units wide by 5 units high: Rough Opening not to exceed 96" x 84" (2438mm x 2134mm).

D. FINISH

1. Exterior: Aluminum clad. Duracron topcoat applied over primer. Meets or exceeds AAMA 2605 requirements.
2. Interior: Aluminum clad. Duracron topcoat applied over primer. Meets or exceeds AAMA 2605 requirements.
3. Colour: Various colours available, contact an Everlast representative for more details.

E. WEATHER STRIP

1. Primary weather strip is an extruded bulb attached to all four sides of the glazing tower by a kerf and provides seal between frame and insulated sealed unit..
2. Standard weather strip color: black.

F. JAMB EXTENSION

1. Standard: factory-installed jamb extension; various sizes and finishes available.

G. GRILLES-BETWEEN-THE-GLASS

1. Manufactured from aluminum profile placed between the two panes of glass.
 - a) Interior Colours : Various colours, including split finishes are available.
 - b) Exterior Colours: Various colours, including split finishes are available.
 - c) Profiles: Various profile shapes are available, contact an Everlast representative.
 - d) Pattern: Various patterns are available, contact an Everlast representative.

- H. SIMULATED DIVIDED LITES (SDL)
 - a) Size: 1" (25mm) wide, 2" (50mm) wide with or w/out internal spacer bar; w/out is standard.
 - b) Colours: Various standard and custom colours available, contact an EVERLAST representative.

- I. ACCESSORIES AND TRIM
 - 1. Exterior Casing:
 - 2. Offset brickmould available in standard and custom colors.
 - 3. Installation Accessories:
 - 4. Factory-installed aluminum nailing fin at head, sill and side jambs.
 - 5. Installation brackets
 - 6. Mullion kit: standard mullion kit for filed assembly of related units available. Kit includes: Instruction, interior and exterior mull covers and brackets.

PART 3 EXECUTION

3.1. EXAMINATION

- A. Verification of Condition: Before installation, verify openings are plumb, square and of proper dimensions. Report frame defects or unsuitable conditions to the General Contractor and/or Everlast directly before proceeding. Damages or defects must be reported within 72 hours of receipt of finished goods.
- B. Acceptance of Condition: Beginning installation or no notification within the 72 hours confirms acceptance of existing conditions.

3.2. INSTALLATION

- A. Assemble and install window/door unit(s) according to manufacturer's instruction and reviewed shop drawing.
- B. Install sealant and related backing materials at perimeter of unit or assembly in accordance to reviewed shop drawings.
- C. Install accessory items as required.

3.3. FIELD QUALITY CONTROL

- A. Remove visible labels and adhesive residue according to manufacturers' instruction
- B. Unless otherwise specified, water penetration resistance testing shall be conducted per AAMA 502 and ASTM E1105 at 2/3 of the fenestration products design pressure (DP) rating. Water penetration shall be defined in accordance with the test method(s) applied.

3.4. CLEANING

- A. Remove visible labels and adhesive residue according to manufacturer's instruction.
- B. Leave windows and glass in a clean condition.

3.5. PROTECTING INSTALLED CONSTRUCTION

- A. Protecting windows from damage by chemicals, solvents, paint or other construction operations that may cause damage.

END OF SECTION

WINDOW TYPE AND CLASSIFICATIONS

Design Performance Classifications

Product	Air Tested (psf)	Water Tested (Pa)	Design Pressure (Pa / psf)		Cert. Rating	Test Size			
						Max Overall Width		Max Overall Height	
						in	mm	in	mm
Low Picture (LFP)	FIXED	730	2880/ -2880	60	CW-PG85	78	1981	72	1828

ENERGY STAR

ENERGY STAR® Program - Canada

This technical specification determines how residential windows, doors, and skylights sold in Canada are certified for the ENERGY

STAR® program. This specification is issued by Natural Resources Canada (NRCAN). NRCAN has been authorized by the U.S. Environmental Protection Agency (EPA) to promote and administer the ENERGY STAR name and symbol in Canada. A product must meet this specification in order to be promoted as ENERGY STAR certified in Canada by its manufacturer or authorized agent. Manufacturers must also sign a Fenestration Administrative Arrangement with NRCAN.

Performance metrics

U-Factor: The heat transfer per time per area and per degree of temperature difference in $W/m^2 \cdot K$ ($Btu/h \text{ ft}^2 \cdot ^\circ F$). The U-factor multiplied by the interior-exterior temperature difference and by the projected fenestration product area yields the total heat transfer

through the fenestration product due to conduction, convection, and long-wave infra-red radiation. A U-factor in $Btu/h \text{ ft}^2 \cdot ^\circ F$ multiplied by 5.678263 converts the value to $W/m^2 \cdot K$. The U-factor in $Btu/h \text{ ft}^2 \cdot ^\circ F$ shall conform with Table 1 before the conversion to $W/m^2 \cdot K$.

Solar heat gain coefficient (SHGC): The ratio of the solar heat gain entering the space through the fenestration product to the incident solar radiation.

Air leakage: the flow of air that passes through fenestration products in $L/s/m^2$. Air leakage infiltration is the flow of air into the building envelope and exfiltration is the flow of air out of the building envelope. An air leakage in cfm/ft^2 multiplied by 5.08 converts the value to $L/s/m^2$. The air leakage value in cfm/ft^2 shall conform with Table 1 before the conversion to $L/s/m^2$.

Energy rating (ER): a unitless value derived from a formula that balances heat loss (U-factor), air leakage loss and potential passive solar gain of a fenestration product. The ER is applied to fenestration systems intended to be installed in a vertical orientation in low-rise residential buildings. The simplified ER equation is as follows:

$$ER = (57.76 \times SHGC_w) - (21.90 \times U_w) - (1.97 \times L_{75}) + 40 \text{ where}$$

- $SHGC_w$ = fenestration system solar heat gain coefficient
- U_w = fenestration system U-factor (W/m^2)
- L_{75} = fenestration system air leakage rate at a pressure difference of 75 Pa, established in accordance with AAMA/WDMA/CSA 101/I.S.2/A440 (North American Fenestration Standard) in $L/s \cdot m^2$. The L_{75} shall be the average of the infiltration and exfiltration measurements.

A complete explanation of the ER equation may be found in the CSA A440.2 Standard.

U-factor Criteria for Residential Windows and Doors

Product	Maximum U-factor W/m²·K	Maximum U-factor Btu/h·ft²·°F
Windows and Doors	1.22	0.21

Alternate ER Criteria for Residential Windows and Doors

Product	Minimum ER (unitless)
Windows and Doors	34

U-factor Criteria for Unit Skylights

Product	Maximum U-factor W/m²·K	Maximum U-factor Btu/h·ft²·°F
Skylights	2.29	0.4

THERMAL RESULTS

LOW FIXED PICTURE WINDOW

Mfr Product Code	Product Number	Gap 1 (in)	Gap 2 (in)	Gap Fill 1	Gap Fill 2	Emissivity Surface 2	Emissivity Surface 3	Emissivity Surface 4	Emissivity Surface 5	Emissivity Surface 6	Tint	Spacer	Grid Type	Grid Size	U-Factor (Btu/h*F ²)	SHGC	VT	*CR
CCI-arg97-180 3-3, ga	0001	0.65		ARG		0.068					CL	SP-D	N		0.27	0.59	0.68	61
CCI-arg97-180 3-3, ga, Rectangular		0.65		ARG		0.068					CL	SP-D	G	0.75	0.27	0.54	0.61	61
CCI-arg97-180 4-4, ga	0002	0.57		ARG		0.068					CL	SP-D	N		0.27	0.58	0.68	60
CCI-arg97-180 4-4, ga, Rectangular		0.57		ARG		0.068					CL	SP-D	G	0.75	0.27	0.52	0.61	60
CCI-arg97-180 5-5, ga	0003	0.49		ARG		0.068					CL	SP-D	N		0.27	0.57	0.67	59
CCI-arg97-180 5-5, ga, Rectangular		0.49		ARG		0.068					CL	SP-D	G	0.75	0.27	0.51	0.60	59
270-arg97-CCI 3-3, ga	0004	0.65		ARG		0.035					CL	SP-D	N		0.26	0.32	0.60	61
270-arg97-CCI 3-3, ga, Rectangular		0.65		ARG		0.035					CL	SP-D	G	0.75	0.26	0.29	0.54	61
270-arg97-CCI 4-4, ga	0005	0.57		ARG		0.035					CL	SP-D	N		0.26	0.31	0.60	60
270-arg97-CCI 4-4, ga, Rectangular		0.57		ARG		0.035					CL	SP-D	G	0.75	0.26	0.28	0.53	60
270-arg97-CCI 5-5, ga	0006	0.49		ARG		0.035					CL	SP-D	N		0.26	0.31	0.59	59
270-arg97-CCI 5-5, ga, Rectangular		0.49		ARG		0.035					CL	SP-D	G	0.75	0.26	0.28	0.53	59
366-arg97-CCI 3-3, ga	0007	0.65		ARG		0.020					CL	SP-D	N		0.26	0.23	0.56	62
366-arg97-CCI 3-3, ga, Rectangular		0.65		ARG		0.020					CL	SP-D	G	0.75	0.26	0.21	0.50	62
366-arg97-CCI 4-4, ga	0008	0.57		ARG		0.020					CL	SP-D	N		0.26	0.24	0.55	61
366-arg97-CCI 4-4, ga, Rectangular		0.57		ARG		0.020					CL	SP-D	G	0.75	0.26	0.21	0.50	61
366-arg97-CCI 5-5, ga	0009	0.49		ARG		0.020					CL	SP-D	N		0.25	0.24	0.55	60
366-arg97-CCI 5-5, ga, Rectangular		0.49		ARG		0.020					CL	SP-D	G	0.75	0.25	0.21	0.49	60
180-arg97-i89 3-3, ga	0010	0.65		ARG		0.068	0.149				CL	SP-D	N		0.22	0.54	0.67	48
180-arg97-i89 3-3, ga, Rectangular		0.65		ARG		0.068	0.149				CL	SP-D	G	0.75	0.22	0.49	0.60	48
180-arg97-i89 4-4, ga	0011	0.57		ARG		0.068	0.149				CL	SP-D	N		0.22	0.52	0.66	47
180-arg97-i89 4-4, ga, Rectangular		0.57		ARG		0.068	0.149				CL	SP-D	G	0.75	0.22	0.47	0.59	47
180-arg97-CCI-arg97-CCI 3-3-3, ga	0012	0.45	0.45	ARG	ARG	0.068					CL	SP-D	N		0.21	0.51	0.63	68
180-arg97-CCI-arg97-CCI 3-3-3, ga, Rectangular	0013	0.45	0.45	ARG	ARG	0.068					CL	SP-D	G	0.75	0.22	0.46	0.56	68
270-arg97-CCI-arg97-180 3-3-3, ga	0014	0.45	0.45	ARG	ARG	0.035		0.068			CL	SP-D	N		0.16	0.29	0.53	75
270-arg97-CCI-arg97-180 3-3-3, ga, Rectangular	0015	0.45	0.45	ARG	ARG	0.035		0.068			CL	SP-D	G	0.75	0.16	0.26	0.48	75
270-arg97-CCI-arg97-CCI 3-3-3, ga	0016	0.45	0.45	ARG	ARG	0.035					CL	SP-D	N		0.20	0.29	0.55	69
270-arg97-CCI-arg97-CCI 3-3-3, ga, Rectangular	0017	0.45	0.45	ARG	ARG	0.035					CL	SP-D	G	0.75	0.21	0.27	0.49	69
270-arg97-CCI-arg97-270 3-3-3, ga	0018	0.45	0.45	ARG	ARG	0.035		0.035			CL	SP-D	N		0.15	0.27	0.47	75
270-arg97-CCI-arg97-270 3-3-3, ga, Rectangular	0019	0.45	0.45	ARG	ARG	0.035		0.035			CL	SP-D	G	0.75	0.16	0.25	0.42	75
366-arg97-CCI-arg97-CCI 3-3-3, ga	0020	0.45	0.45	ARG	ARG	0.020					CL	SP-D	N		0.20	0.22	0.51	69

CROSS SECTIONS

LOW FIXED PICTURE WINDOW

22mm (7/8") DUAL PANE GLASS

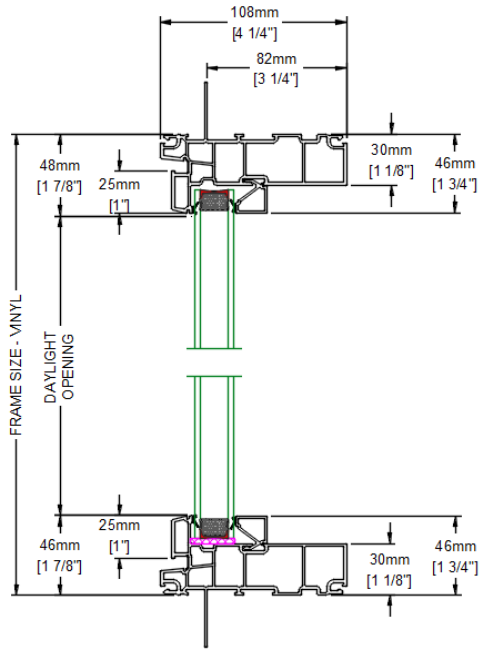

HEAD JAMB + SILL

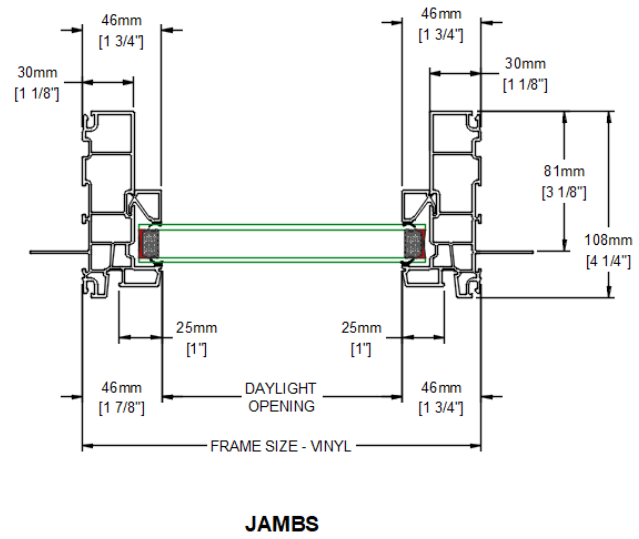

JAMBS

31.75mm (1 1/4") TRIPLE PANE GLASS

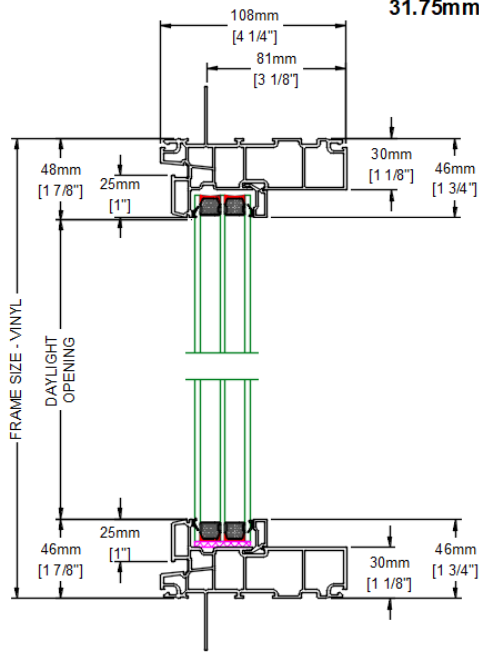

HEAD JAMB + SILL

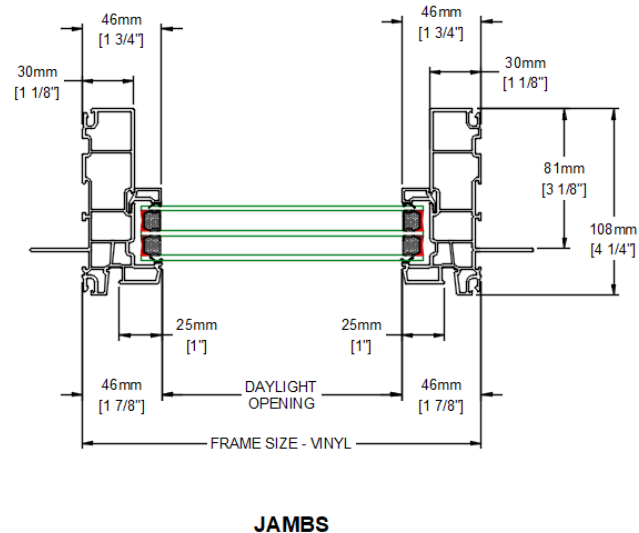

JAMBS

MULLING ASSEMBLY

LOW FIXED PICTURE
MULLED LOW FIXED PICTURE

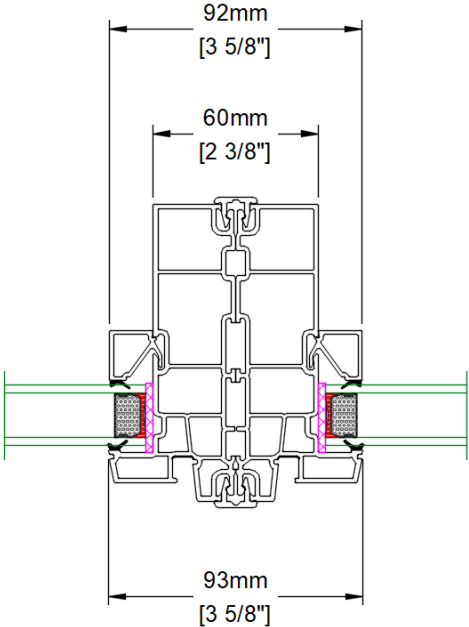

STANDARD MULL

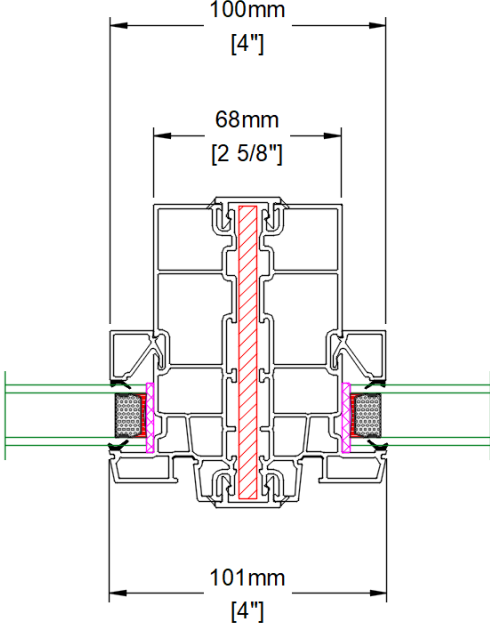

FLAT PLATE STEEL MULL

GRILL + SDL OPTIONS

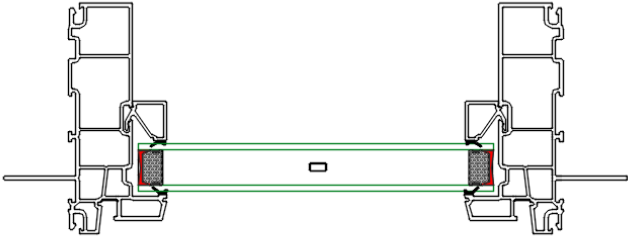

5/16" In-Glass Grill

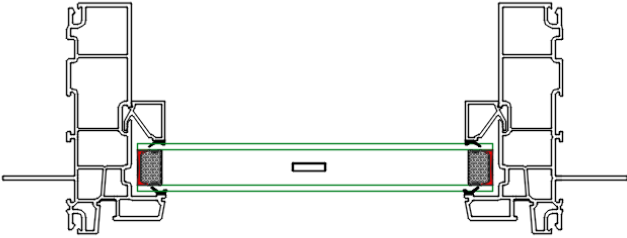

5/8" In-Glass Grill

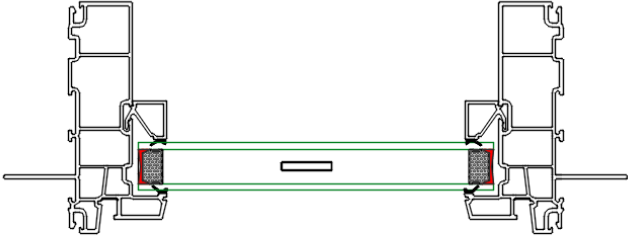

1" In-Glass Grill

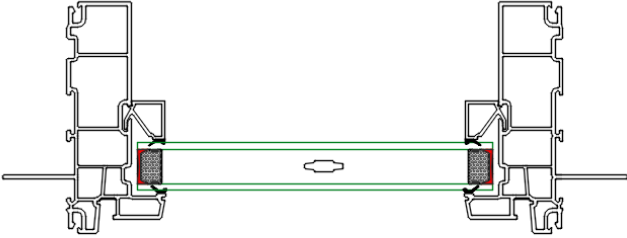

23/32" Contour In-Glass Grill

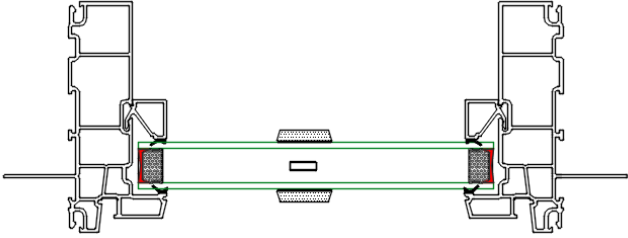

1" SDL PROFILE

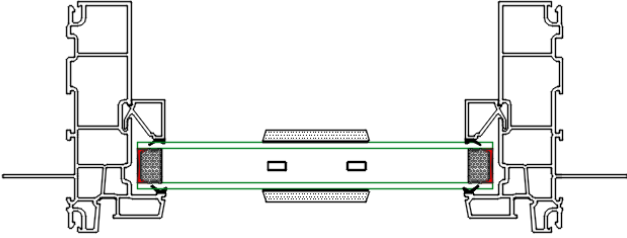

2" SDL PROFILE

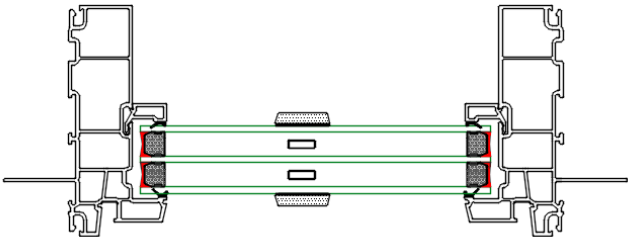

1" SDL PROFILE

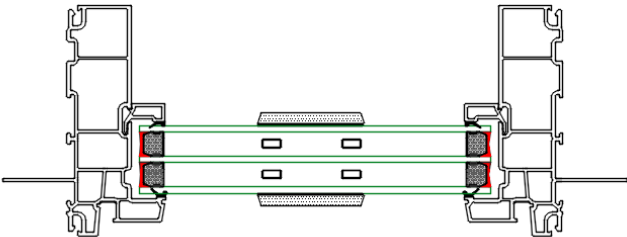

2" SDL PROFILE

TEST REPORTS

PERFORMANCE TESTS IN ACCORDANCE WITH
AAMA/WDMA/CSA 101/I.S.2/A440-08 & A440S1-09

 <p>Report No.: AI-04196-N1</p>	<p>Product Manufacturer:</p> <p>NEXTRUSIONS 10500, RUE COLBERT MONTRÉAL, QUEBEC H1J 2H8 514-355-6868</p>																		
<p>Test Report Summary:</p> <table><tr><td>Product type:</td><td>PVC Fixed Window</td></tr><tr><td>Product series/model:</td><td>3000/4000 Series Fixed Window (Small Picture) – 5 mm glass</td></tr><tr><td>Primary product designator:</td><td>Class CW-PG85-FW Size tested 1980 x 1830 (78 x 72)</td></tr><tr><td>Optional secondary designator:</td><td>Positive Design pressure (DP) = 4080 Pa (85.0 psf) Negative design pressure (DP) = -4080 Pa (-85.0 psf) Water penetration resistance test pressure = 730 Pa (15.0 psf) Canadian air infiltration / exfiltration level = Fixed Level</td></tr><tr><td>Test completion date:</td><td>09/11/2014</td></tr><tr><td>Report date:</td><td>09/24/2014</td></tr><tr><td>Revision date:</td><td>-</td></tr><tr><td>Number of pages:</td><td>5</td></tr><tr><td>CAN/CSA A440-00 ratings:</td><td>FIXED / B7 / C5</td></tr></table> <p>Note: Reference must be made to Air-Ins Inc. complete report for test specimen description and detailed test results.</p>		Product type:	PVC Fixed Window	Product series/model:	3000/4000 Series Fixed Window (Small Picture) – 5 mm glass	Primary product designator:	Class CW-PG85-FW Size tested 1980 x 1830 (78 x 72)	Optional secondary designator:	Positive Design pressure (DP) = 4080 Pa (85.0 psf) Negative design pressure (DP) = -4080 Pa (-85.0 psf) Water penetration resistance test pressure = 730 Pa (15.0 psf) Canadian air infiltration / exfiltration level = Fixed Level	Test completion date:	09/11/2014	Report date:	09/24/2014	Revision date:	-	Number of pages:	5	CAN/CSA A440-00 ratings:	FIXED / B7 / C5
Product type:	PVC Fixed Window																		
Product series/model:	3000/4000 Series Fixed Window (Small Picture) – 5 mm glass																		
Primary product designator:	Class CW-PG85-FW Size tested 1980 x 1830 (78 x 72)																		
Optional secondary designator:	Positive Design pressure (DP) = 4080 Pa (85.0 psf) Negative design pressure (DP) = -4080 Pa (-85.0 psf) Water penetration resistance test pressure = 730 Pa (15.0 psf) Canadian air infiltration / exfiltration level = Fixed Level																		
Test completion date:	09/11/2014																		
Report date:	09/24/2014																		
Revision date:	-																		
Number of pages:	5																		
CAN/CSA A440-00 ratings:	FIXED / B7 / C5																		

Prepared by :

Digitally Signed by:
Éric Perron, Tech.
Physical Testing Department
Air-Ins Inc.

Approved by :

Digitally Signed by:
Jean Miller, Eng.
Director, Physical Testing Department
Air-Ins Inc.

 **AIR-INS inc.**
1320, boul. Lionel-Boulet,
Varenes (Québec) J3X 1P7
☎ (450) 652-0838
☎ (450) 652-7588
✉ info@air-ins.com